

# Foundation Repair for the Life of Your Home

Foundation failure is one of the most serious threats to a home and one of the most dismaying situations you as a homeowner can face. Annoyances such as sticking doors and windows or unsightly cracks in walls and masonry are signs of structural failure that, unless corrected, produce more serious structural damage, creating unsafe conditions and drastically reducing a home's value.

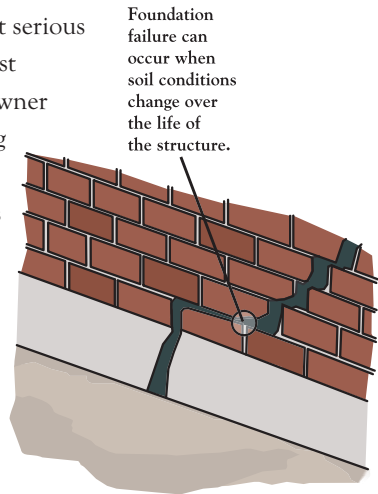

## Why choose The Stabilizer®?

The Stabilizer® is an innovative helical piercing system that uses the latest technology to gently lift and permanently support homes damaged by foundation failure. Compared to conventional piercing systems and other foundation repair options:

- The Stabilizer® is stronger—stronger than it has to be. Some systems use thin-shaft anchors or piers that may “kink,” or buckle, if the weight of the house exceeds the capacity of the anchors. The Stabilizer® uses 3 1/2-inch-diameter, structurally rated steel piles that are more than twice as strong as piers found in other systems.
- The Stabilizer® is always installed to full capacity, regardless of the weight of the house. Some other systems rely on an estimate of your home's weight to determine the installation force required and still others use the actual weight of your house to push their piers into the ground. These approaches can lead to problems later on if the estimate is incorrect or if soil conditions change.
- The Stabilizer® holds its ground in all types of soils and soil conditions. Its helical piles are rotated—not pushed—into the ground, so they stay in place and will stay in place regardless of soil conditions.

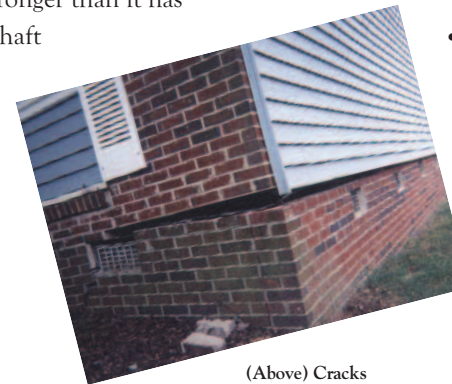

(Above) Cracks as thin as a nickel indicate structural damage; but, we can even fix severe failures.

## Why do foundations fail?

Most foundation failure results from soil-related problems such as expansive soils that expand and shrink with changes in the moisture content of the soil, poor compaction, overloading, excessive organic materials or erosion. These conditions create instabilities that can damage a home's foundation as well as the rest of the structure.

**What's the solution?** Fortunately, there are ways to restore stability, raise settled areas and repair damage inside and outside a home. Some systems and techniques, however, produce cosmetic results only; they do little or nothing to correct the source of the problem. And with so many options available, the choice may seem difficult. Actually, the decision is easy—once you have seen The Stabilizer®

manufactured by Atlantic Foundation & Repair.

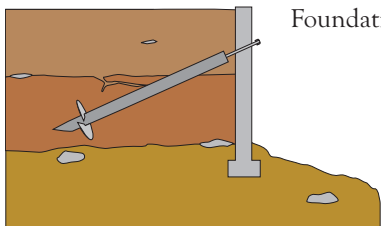

The Stabilizer® works equally well in tension applications.

- The Stabilizer® is gentle. It lifts a house only when setting it back in place. By contrast, push pier systems, which repeatedly lift a house, use the house's weight to push the piers into the ground. Repeated lifting can produce “walk out,” a term applied when a section of the house moves away from the rest of the structure.
- The Stabilizer® adjusts to protect the foundation and itself. It is the only system available that connects each pile to the foundation with a patented articulating bracket that pivots during the lifting and stabilization process. This movement ensures that brackets remain aligned with the foundation, preventing damage to the piles, the brackets and the foundation. Without this “give,” the results can be induced foundation failure or bending failure points.

## Guaranteed—for the life of your home.

Each installation of The Stabilizer® is guaranteed in writing for life, and the warranty is transferable should you sell your home. Some systems offer only temporary or partial solutions, and their warranties include a variety of disclaimers. The Stabilizer® is designed to be a permanent and total solution that will restore your peace of mind and protect your home's value in the years to come. Guaranteed.



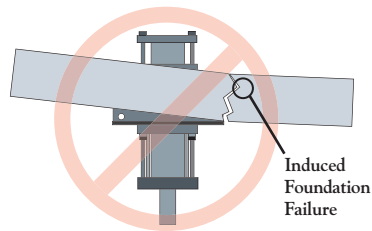

Standard Bracket

Induced Foundation Failure

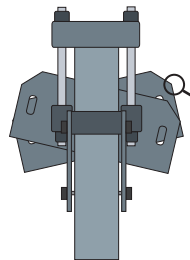

AF&R's Patented Articulating Bracket

Eliminates Failure Points

The Stabilizer® gently lifts the foundation back into place

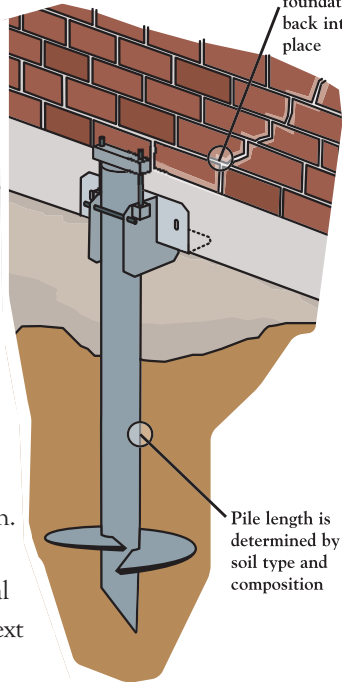

Pile length is determined by soil type and composition

### How The Stabilizer® Works

1. An excavation is made beside the foundation, at each installation point, to a depth just beneath the foundation.
2. Using a torque motor, installers screw a helical pile into the ground next to the foundation.
3. When the pile is in place, tops are sawed off at a height to ensure no pile components are visible above ground.
4. Installers position the articulating bracket and attach a hydraulic jack to the top of the bracket. The jack then lifts the foundation back into place, and the bracket is locked into its required position.



© Atlantic Foundation and Repair

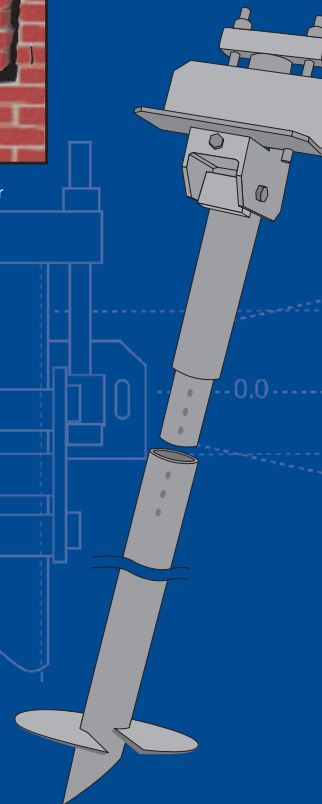

### Atlantic Foundation & Repair

#### Wendell, NC

2555 Wendell Blvd.  
Wendell, NC 27591  
Phone 919-365-9444  
Fax 919-365-7050

#### Raleigh, NC

Phone: 919-855-0855  
Fax: 919-855-0979  
Toll-free: 877-PIERS-40 (877-743-7740)

[www.atlantic-foundation.com](http://www.atlantic-foundation.com)

©Copyright 2004 Atlantic Foundation & Repair, LLC

The Stabilizer® and "We Fix Broken Homes®" are registered trademarks of Atlantic Foundation & Repair



# Foundation Repair for the Life of Your Home



### Atlantic Foundation & Repair

